

Features

- Epitaxial Planar Die Construction
- Complementary PNP Types Available (DDTA)
- Built-In Biasing Resistors, R1≠R2
- **Lead Free/RoHS Compliant (Note 1)**
- **"Green" Device (Note 2 & 3)**

Mechanical Data

- Case: SOT-323
- Case Material: Molded Plastic, "Green" Molding Compound, Note 3. UL Flammability Classification Rating 94V-0
- Moisture Sensitivity: Level 1 per J-STD-020C
- Terminal Connections: See Diagram
- Terminals: Solderable per MIL-STD-202, Method 208
- Lead Free Plating (Matte Tin Finish annealed over Alloy 42 leadframe).
- Marking Information: See Page 4
- Type Code: See Table Below
- Ordering Information: See Page 4
- Weight: 0.006 grams (approximate)

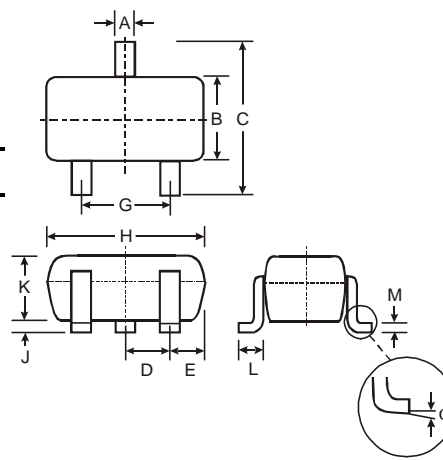

SOT-323		
Dim	Min	Max
A	0.25	0.40
B	1.15	1.35
C	2.00	2.20
D	0.65 Nominal	
E	0.30	0.40
G	1.20	1.40
H	1.80	2.20
J	0.0	0.10
K	0.90	1.00
L	0.25	0.40
M	0.10	0.18
α	0°	8°
All Dimensions in mm		

P/N	R1 (NOM)	R2 (NOM)	Type Code
DDTC113ZUA	1K Ω	10K Ω	N02
DDTC123YUA	2.2K Ω	10K Ω	N05
DDTC123JUA	2.2K Ω	47K Ω	N06
DDTC143XUA	4.7K Ω	10K Ω	N09
DDTC143FUA	4.7K Ω	22K Ω	N10
DDTC143ZUA	4.7K Ω	47K Ω	N11
DDTC114YUA	10K Ω	47K Ω	N14
DDTC114WUA	10K Ω	4.7K Ω	N15
DDTC124XUA	22K Ω	47K Ω	N18
DDTC144VUA	47K Ω	10K Ω	N21
DDTC144WUA	47K Ω	22K Ω	N22

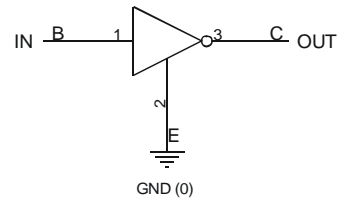
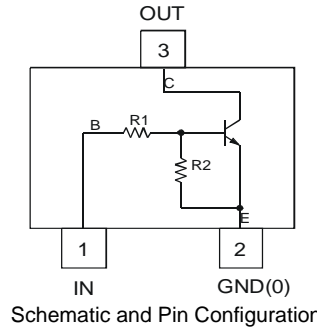

Maximum Ratings @T_A = 25°C unless otherwise specified

Characteristic	Symbol	Value	Unit
Supply Voltage, (3) to (2)	V _{CC}	50	V
Input Voltage, (1) to (2)	V _{IN}	-5 to +10 -5 to +12 -5 to +12 -7 to +20 -6 to +30 -5 to +30 -6 to +40 -10 to +30 -10 to +40 -15 to +40 -10 to +40	V
Output Current	I _O	100 100 100 100 100 100 70 100 50 30 30	mA
Output Current	I _C (Max)	100	mA

- Notes:
1. No purposefully added lead.
 2. Diodes Inc.'s "Green" policy can be found on our website at http://www.diodes.com/products/lead_free/index.php.
 3. Product manufactured with Date Code 0627 (week 27, 2006) and newer are built with Green Molding Compound. Product manufactured prior to Date Code 0627 are built with Non-Green Molding Compound and may contain Halogens or Sb2O3 Fire Retardants.

Maximum Ratings (continued) @T_A = 25°C unless otherwise specified

Characteristic	Symbol	Value	Unit
Output Current	I _C (Max)	100	mA
Power Dissipation	P _d	200	mW
Thermal Resistance, Junction to Ambient Air (Note 4)	R _{θJA}	625	°C/W
Operating and Storage Temperature Range	T _J , T _{STG}	-55 to +150	°C

Notes: 4. Mounted on FR4 PC Board with recommended pad layout at <http://www.diodes.com/datasheets/ap02001.pdf>.

Electrical Characteristics @T_A = 25°C unless otherwise specified

Characteristic	Symbol	Min	Typ	Max	Unit	Test Condition	
Input Voltage	V _{I(off)}	0.3			V	V _{CC} = 5V, I _O = 100μA	
		0.3					
		0.5					
		0.3					
		0.3					
		0.5	—	—			
		0.3					
		0.8					
		0.4					
		1.0					
0.8							
Input Voltage	V _{I(on)}			3.0	V	V _O = 0.3V, I _O = 20mA	
				3.0			V _O = 0.3V, I _O = 20mA
				1.1			V _O = 0.3V, I _O = 5mA
				2.5			V _O = 0.3V, I _O = 20mA
				1.3			V _O = 0.3V, I _O = 3mA
				1.3			V _O = 0.3V, I _O = 5mA
				1.4			V _O = 0.3V, I _O = 1mA
				3.0			V _O = 0.3V, I _O = 2mA
				2.5			V _O = 0.3V, I _O = 2mA
				5.0			V _O = 0.3V, I _O = 2mA
		4.0	V _O = 0.3V, I _O = 2mA				
Output Voltage	V _{O(on)}	—	0.1	0.3	V	I _O /I _I = 5mA/0.25mA DDTC123JUA I _O /I _I = 5mA/0.25mA DDTC143ZUA I _O /I _I = 5mA/0.25mA DDTC114YUA I _O /I _I = 10mA/0.5mA All Others	
Input Current	I _I			7.2	mA	V _I = 5V	
				3.8			
				3.6			
				1.8			
				1.8			
				1.8			
				0.88			
				0.88			
				0.36			
				0.16			
		0.16					
Output Current	I _{O(off)}	—	—	0.5	μA	V _{CC} = 50V, V _I = 0V	
DC Current Gain	G _I	33			—	V _O = 5V, I _O = 5mA	
		33					V _O = 5V, I _O = 10mA
		80					V _O = 5V, I _O = 10mA
		30					V _O = 5V, I _O = 10mA
		68					V _O = 5V, I _O = 10mA
		80	—	—			V _O = 5V, I _O = 10mA
		68					V _O = 5V, I _O = 5mA
		24					V _O = 5V, I _O = 10mA
		68					V _O = 5V, I _O = 5mA
		33					V _O = 5V, I _O = 5mA
56			V _O = 5V, I _O = 5mA				
Input Resistor Tolerance	ΔR ₁	-30	—	+30	%	—	
Resistance Ratio Tolerance	ΔR ₂ /R ₁	-20	—	+20	%	—	
Gain-Bandwidth Product*	f _T	—	250	—	MHz	V _{CE} = 10V, I _E = 5mA, f = 100MHz	

* Transistor - For Reference Only

Typical Curves – DDTC123JUA

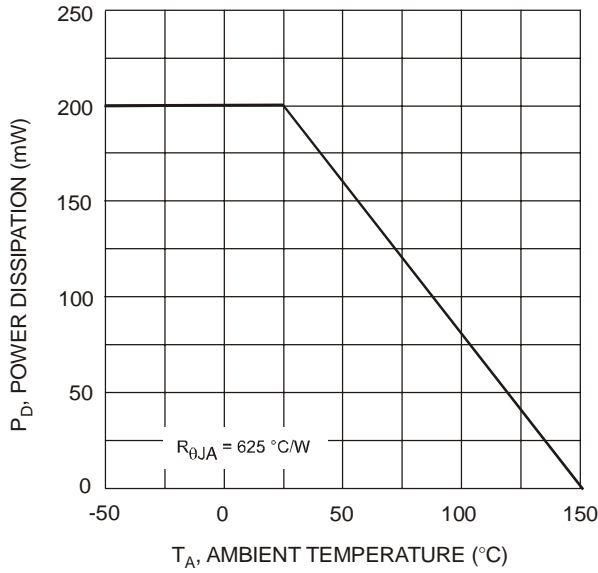

Fig. 1 Derating Curve

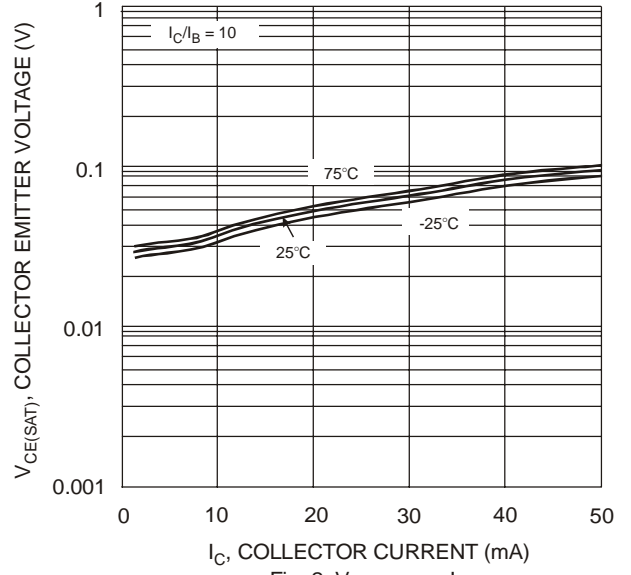

Fig. 2 $V_{CE(SAT)}$ vs. I_C

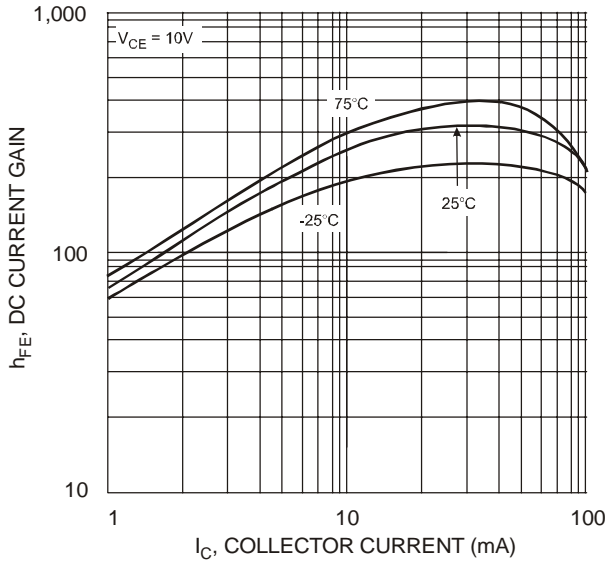

Fig. 3 DC Current Gain

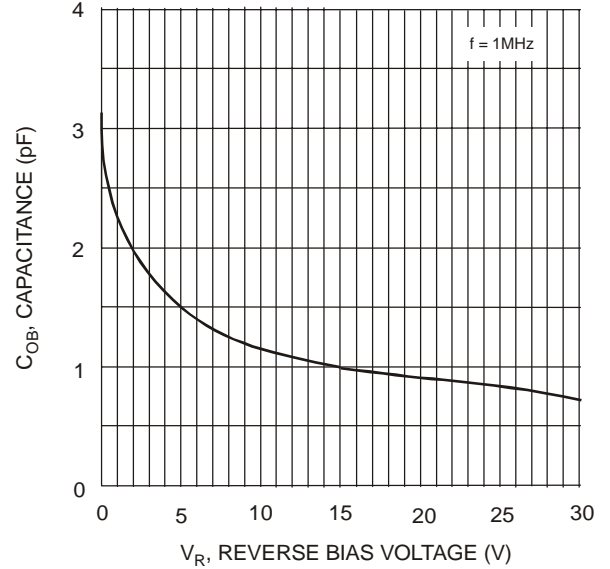

Fig. 4 Output Capacitance

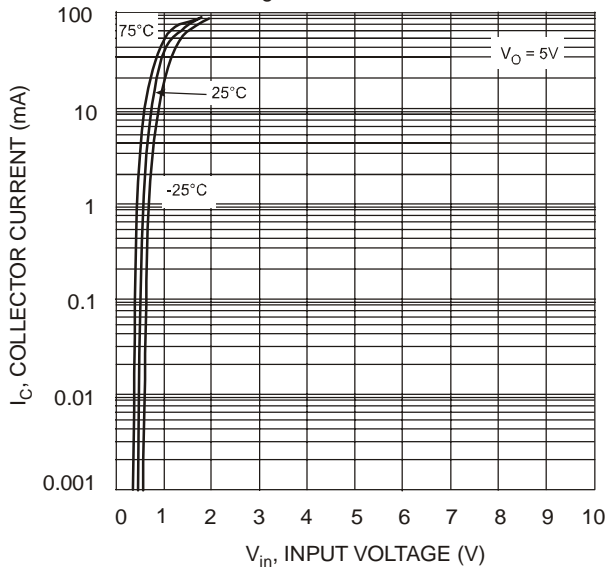

Fig. 5 Collector Current vs. Input Voltage

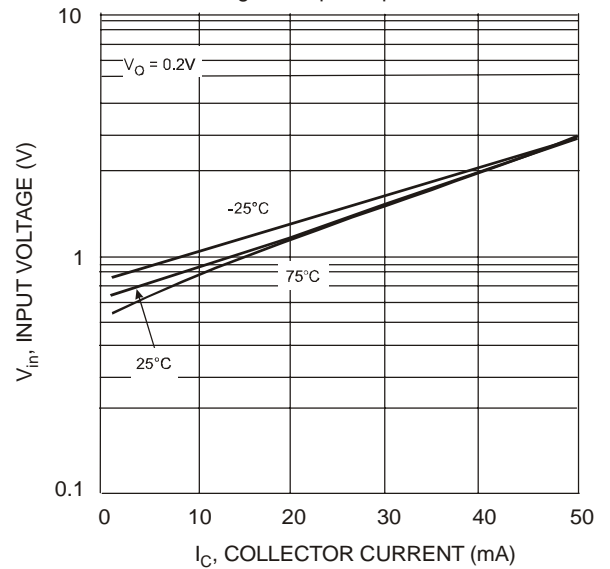

Fig. 6 Input Voltage vs. Collector Current

Ordering Information (Note 3 & 5)

Device	Packaging	Shipping
DDTC113ZUA-7-F	SOT-323	3000/Tape & Reel
DDTC123YUA-7-F	SOT-323	3000/Tape & Reel
DDTC123JUA-7-F	SOT-323	3000/Tape & Reel
DDTC143XUA-7-F	SOT-323	3000/Tape & Reel
DDTC143FUA-7-F	SOT-323	3000/Tape & Reel
DDTC143ZUA-7-F	SOT-323	3000/Tape & Reel
DDTC114YUA-7-F	SOT-323	3000/Tape & Reel
DDTC114WUA-7-F	SOT-323	3000/Tape & Reel
DDTC124XUA-7-F	SOT-323	3000/Tape & Reel
DDTC144VUA-7-F	SOT-323	3000/Tape & Reel
DDTC144WUA-7-F	SOT-323	3000/Tape & Reel

Notes: 5. For packaging details, go to our website at <http://www.diodes.com/datasheets/ap02007.pdf>.

Marking Information

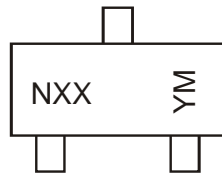

NXX = Product Type Marking Code
See Page 1 Diagrams
YM = Date Code Marking
Y = Year ex: T = 2006
M = Month ex: 9 = September

Date Code Key

Year	2002	2003	2004	2005	2006	2007	2008	2009	2010	2011	2012
Code	N	P	R	S	T	U	V	W	X	Y	Z

Month	Jan	Feb	Mar	Apr	May	Jun	Jul	Aug	Sep	Oct	Nov	Dec
Code	1	2	3	4	5	6	7	8	9	O	N	D

IMPORTANT NOTICE

Diodes Incorporated and its subsidiaries reserve the right to make modifications, enhancements, improvements, corrections or other changes without further notice to any product herein. Diodes Incorporated does not assume any liability arising out of the application or use of any product described herein; neither does it convey any license under its patent rights, nor the rights of others. The user of products in such applications shall assume all risks of such use and will agree to hold Diodes Incorporated and all the companies whose products are represented on our website, harmless against all damages.

LIFE SUPPORT

Diodes Incorporated products are not authorized for use as critical components in life support devices or systems without the expressed written approval of the President of Diodes Incorporated.